

EAC-335x

Hardware User Manual

2020-August

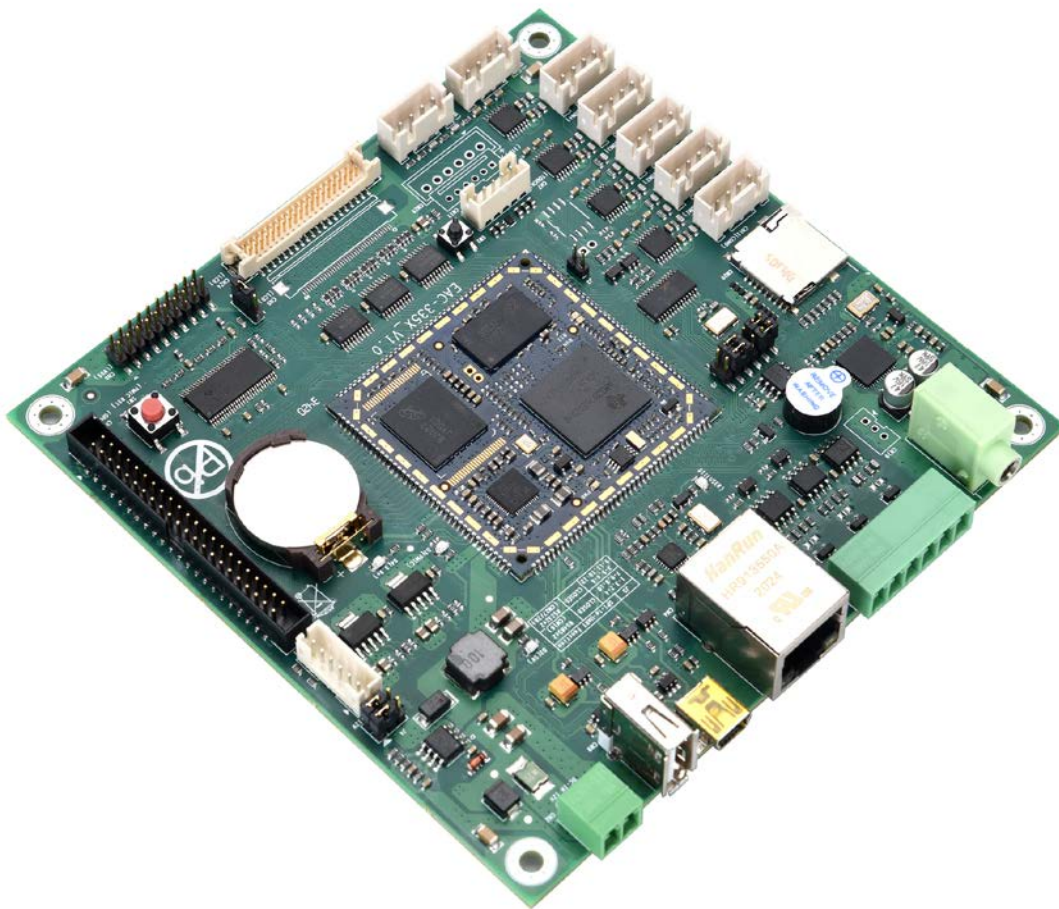

Copyright © 2020 ShenZhen Embedall Technology Co., Ltd.

All Rights Reserved.

Disclaimer :

This documentation is forbidden to be photocopied, reproduced, translated, changed or distributed, or recorded on any electronic media without written consent of ShenZhen Embedall Technology Co., Ltd.

ShenZhen Embedall has made every attempt to ensure that the information in this document is accurate and complete. However, Embedall assumes no responsibility for any errors, omissions, or for any consequences resulting from the use of the information included herein or the equipment it accompanies.

Embedall reserves the right to make changes in its products and specifications at any time without notice. Any software described in this document is furnished under a license or non-disclosure agreement. It is against the law to copy this software on magnetic tape, disk, or other medium for any purpose other than the licensee's personal use.

Trademark Acknowledgment :

Trademarks or registered trademarks used from other companies in this documentation refer to the products of their respective owners.

Company :

Embedall Technology Co.Ltd.

Tel / Fax : +86 0755-82523090

Web : www.embedall.com

E-mail : info@embedall.com

Revision History

Version	Date	Description
V1.0	2020-August	First release

Table of Contents

1	Introduction	1
1.1	Main features	1
1.2	Block diagram.....	2
2	CoM-335X Introduction	3
2.1	Features.....	3
2.2	Block Diagram.....	5
2.3	CoM-335x Features	1
2.4	CoM-335x boot Sequence	2
3	Interfaces	3
3.1	Power supply	5
3.2	Battery.....	5
3.3	LEDs.....	6
3.4	Boot Sequence SWITCH.....	7
3.5	RESET	8
3.6	Ethernet.....	8
3.7	USB	8
3.8	LCD Display-TTL	9
3.9	LCD Touch	12
3.10	LCD Display-LVDS.....	12
3.11	Backlight.....	14
3.12	RS232/TTL.....	15
3.13	RS485+CAN.....	16
3.14	Audio	18
3.15	WatchDog	18
3.16	Buzzer.....	19
3.17	Micro SDCard.....	19
3.18	GPMC Bus.....	19
3.19	I2C Bus	21
4	Electronic Characteristics	22
4.1	Power Supply Electrical Characteristics	22
4.2	IO Electrical Characteristics	22
4.3	Operating Temperature Ranges.....	22
5	Mechanical Characteristics	23

1 Introduction

EAC-335x is a high performance single board computer with the core module CoM-335x. CoM-335x is equipped with TI AM335x processors, DDR3 RAM memory, NAND Flash or eMMC subsystems. The core module provides a complete and flexible CPU infrastructure for highly integrated embedded systems.

EAC-335x is equipped with core module CoM-335x, offers common standard interfaces as well as serial and digital inputs and outputs. Such as LCD interface, USB, Ethernet, UARTs, CAN, etc.

Embfly provides rich software resources and detailed documents with the board, including user manuals, schematic of the base board, peripheral drivers, BSP source packages, development tools and other related information.

1.1 Main features

- TI Cortex-A8 Sitara AM335x SoC, up to 1GHz
- Up to 1GB DDR3
- Up to 1GB NAND or up to 32GB eMMC memory option
- On-board external RTC
- 1x Ethernet 10/100Mbps
- 1x USB Host 2.0
- 1x USB OTG 2.0
- 2x RGB565 display interface (optional)
- 1x LVDS display interface
- 4-wire resistive touch-screen
- 1x Backlight interface
- 2x RS232 (one is debug uart)
- 3x RS232/alternatively TTL is possible
- 2x RS232/alternatively RS485 is possible
- 1x CAN up to 1 Mbaud
- 1x Headphone Jack
- 1x MIC interface (optional)
- 1x Micro SDCard slot

- 1x GPMC bus (works for NAND Flash Option on core module)
- 1x I2C bus
- 1x Buzzer
- 3x Power LEDs
- 1x User LED

1.2 Block diagram

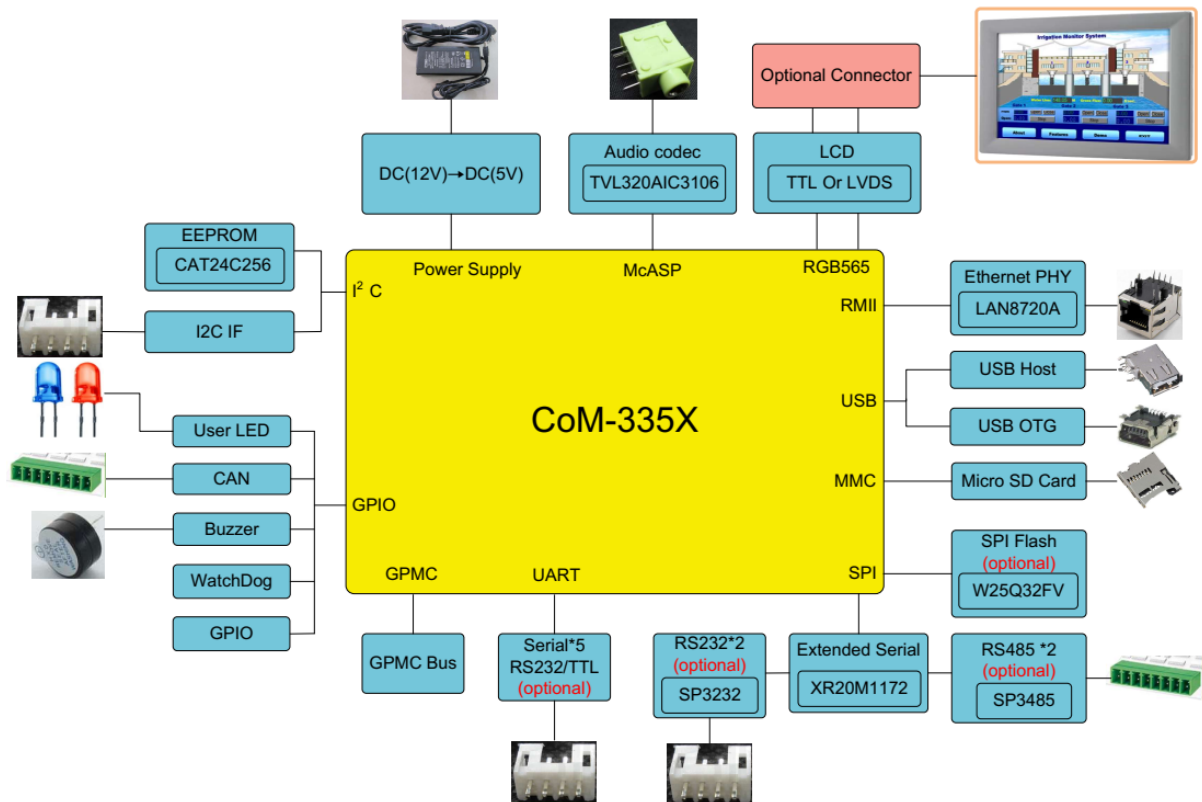

Fig. 1-1 EAC-335x block diagram

2 CoM-335X Introduction

CoM-335x is a highly configurable, small form-factor processor boards features one of Texas Instruments Sitara AM335x Processors. The module includes DDR3 RAM memory and NAND FLASH or eMMC subsystems. CoM-335x provides a complete and flexible CPU infrastructure for highly integrated embedded systems.

The onboard AM335x processor provides Cortex-A8 32-bit RISC processor with a NEON SIMD coprocessor. This MPU is capable of running a rich set of real-time operating systems containing software applications programming interfaces (APIs) expected by modern system designers. The ARM architecture supports several operating systems, including Linux, QNX, and Windows CE.



NAND FLASH启动



EMMC 启动

CoM-335x with NAND Flash Option (left) and eMMC Option (right)

2.1 Features

- Texas Instruments Cortex-A8 Sitara AM335x SoC, up to 1GHz
- Up to 1GB DDR3
- Up to 1GB NAND or up to 32GB eMMC memory option
- CRYPTO or EEPROM
- On-board external RTC
- Display controller with support of up to WXGA (1366 x 768) resolution

- PowerVR SGX GPU with OpenGL-ES and OpenVG support
- Gigabit Ethernet, USB2.0x2, UARTx6, SDIOx3, SPIx2, I²Cx2, CAN,ADC, GPIOs
- Linux, Windows Embedded Compact 7
- Tiny size: 45.00x45.00x2.0 mm

2.2 Block Diagram

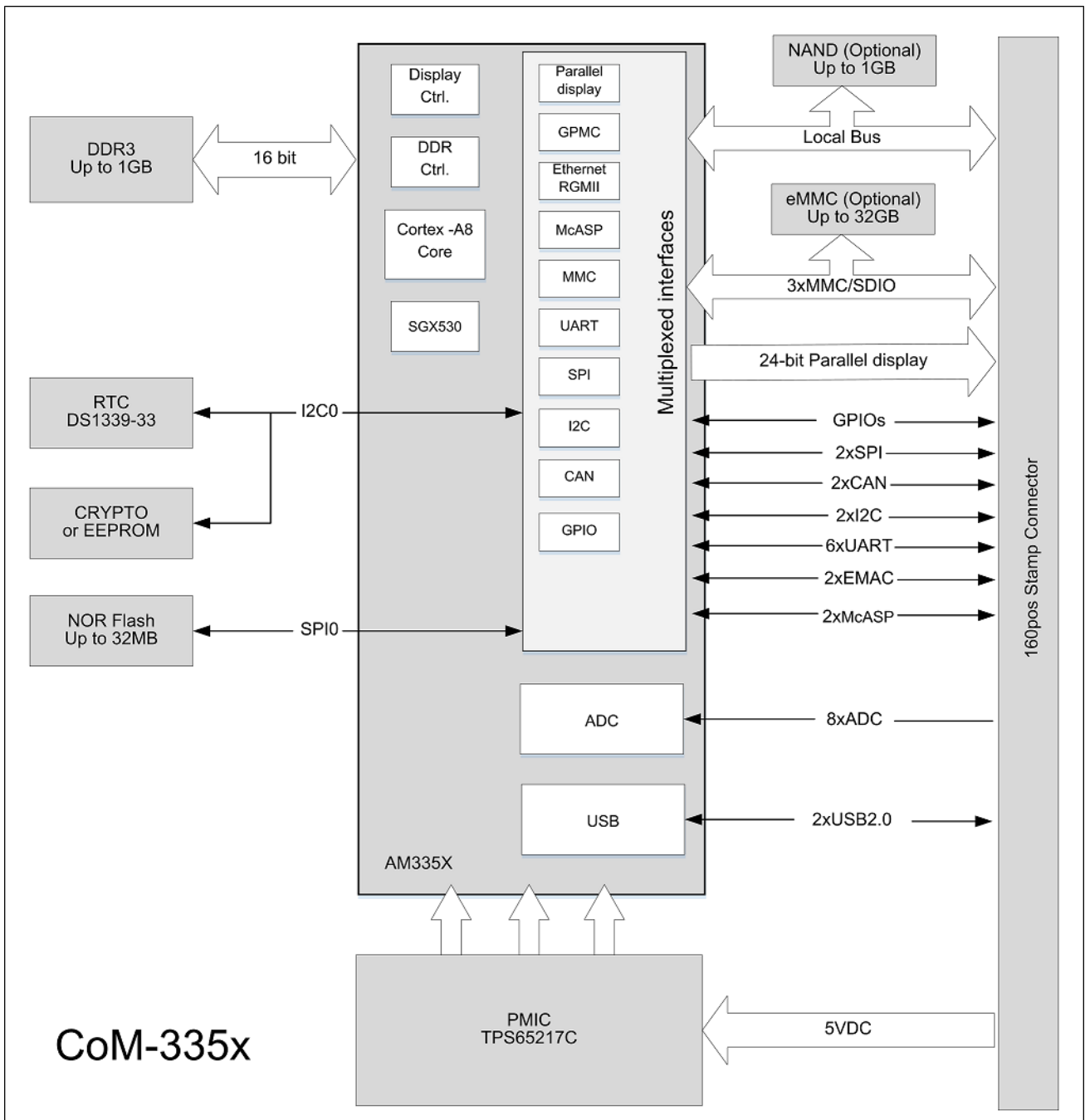

CoM-335x Block Diagram

2.3 CoM-335x Features

System and Graphics

Feature	Specifications
CPU	TI ARM Cortex-A8 processor AM335x, up to 1GHz 32KB (L1) + 256KB (L2) cache
RAM	Up to 1GB, DDR3, 16-bit bus width
Memory	On-board NAND flash or eMMC option: NAND flash up to 1GB, 8bit, SLC eMMC up to 32GB, 8bit
	On-board NOR flash, up to 32MB, SPI
	On-board CRYPTO or EEPROM optional
RTC	On-board external RTC
Power	TPS65217C
Graphics Acceleration Unit	PowerVR SGX530 GPU providing 2D/3D graphics acceleration with OpenGL-ES and OpenVG support.

Peripherals Interface

Feature	Specifications
Display	Parallel 24-bit display interface - up to 1366 x 768
USB	2 OTG USB2.0 high-speed ports, 480 Mbps
UART	Up to 6 UART ports
CAN bus	Up to 2 CAN bus interfaces, 3.3V levels
MMC / SDIO	Up to 3 MMC/SD/SDIO interfaces, support for HC MMC and SDHC up to 32GB
I2C	Up to 2 I2C interfaces (up to 400Kbps)
SPI	Up to 2 configurable SPI bus interfaces (Slave/Master modes)
General Purpose IO	A lot of multifunction signals can be used as GPIOs (shared with other functions, can not available simultaneously)
Audio	Up to Two Multichannel Audio Serial Ports(McASPs)
ADC	Up to 8 general-purpose ADC channels
Gigabit Ethernet	Up to Two Industrial Gigabit Ethernet MACs (10,100, 1000 Mbps)
Touch-screen	4/5/8-wire resistive touch-screen support

Electrical, Mechanical and Environmental Specifications

Feature	Specifications
Supply Voltage	5V DC main power supply
Active power consumption	Depending on board configuration, CPU speed and system load.
Dimensions	45.00 x45.00x2.0 mm
Operation temperature (case)	Commercial: 0 to70 °C Extended: -20 to 70 °C Industrial: -30 to 80 °C
Storage temperature	-40 to 85 °C
Relative humidity	10% to 90% (operation) 05% to 95% (storage)
Connectors	160pos stamp connector

2.4 CoM-335x boot Sequence

On system startup, the boot sequence is configured according to sysboot inputs(**Please refer AM335x and AMIC110 Sitara™ Processors Technical Reference Manual--<https://www.ti.com/lit/pdf/spruh73>**).After booting device list creation, the processor initiates a booting procedure. If a boot image is found on a device(for example:nand flash), the boot code executes. Otherwise, the next boot device enumerated in the list is examined.

On the CoM-335x, We support three kinds of boot devices: NAND flash, EMMC and micro SD card.the sysboot inputs have been tied to the right level, and it can change the boot device through the signal LCD_D2 of CoM-335x(pin4).

Boot sequence of different configurations on CoM-335x are detailed in following Table:

Boot Sequence of CoM-335x (NAND Flash on board)

LCD_D2	1st	2nd	3rd	4th	Description
LOW	NAND	NANDI2C	MMC0	UART0	When LCD_D2 tie to LOW,NAND Flash (NAND) is the first boot device
HIGH	MMC0	SPI0	UART0	USB0	When LCD_D2 tie to HIGH, it can change the boot device to SDcard (MMC0) or the other

Boot Sequence of CoM-335x (eMMC on board)

LCD_D2	1st	2nd	3rd	4th	Description
HIGH	MMC1	MMC0	UART0	USB0	When LCD_D2 tie to HIGH,eMMC (MMC1) is the first boot device
LOW	SPI0	MMC0	USB0	UART0	When LCD_D2 tie to LOW, it can change the boot device to SDcard (MMC0) or the

					other
--	--	--	--	--	-------

3 Interfaces

The following subsections describe all of the interfaces of EAC-335x. The Figure below serves as an overview for the subsections that follow.

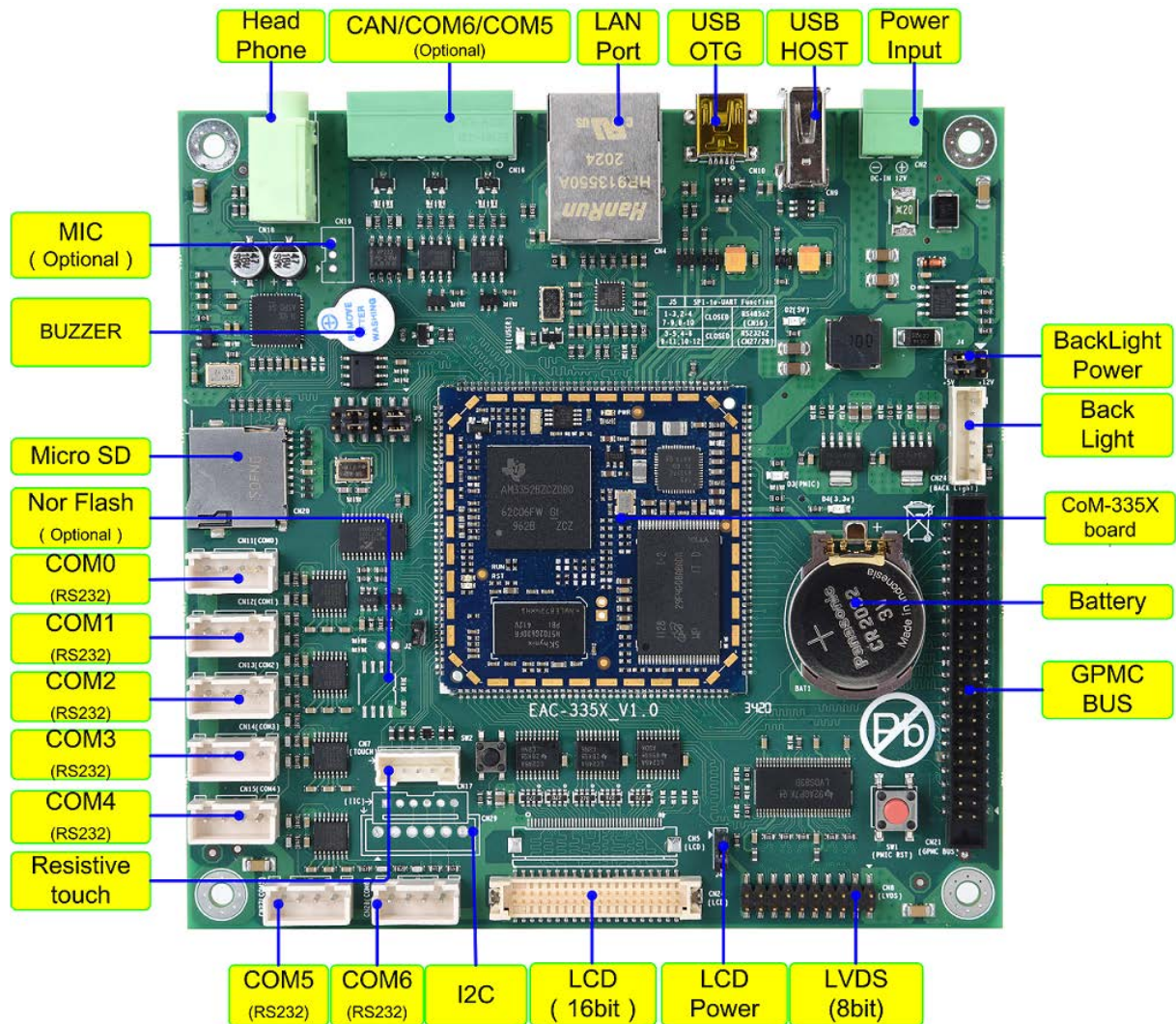

Overview of the interfaces of EAC-335x

Feature	Interface	Ref.	Description
Core Module	Core Module IF	CN1	CoM-335x Module
Power Supply	DC Jack(2.5mm)	CN2	12V DC input
RTC	RTC Battery	BAT1	3V lithium battery(CR2032)
USB	MINI USB	CN10	USB OTG
	Type-A USB	CN9	USB Host x 1

Ethernet	LAN	CN4	10/100Mbps Ethernet
UART	Debug UART0	CN11	COM0,RS232, for debug
	UART1	CN12	COM1,RS232,2-Wire UART
	UART2	CN13	COM2,RS232(LVTTL Optional),2-Wire UART
	UART3	CN14	COM3,RS232(LVTTL Optional),2-Wire UART
	UART4	CN15	COM4,RS232(LVTTL Optional),2-Wire UART
	UART5/UART6(RS485)	CN16	COM5,RS485; COM6,RS485;
	UART5/UART6(RS232)	CN27/CN28	COM5,RS232; COM6,R232;
	UART5/UART6 RS485/RS232 Selection	J5	Through the jumper, The UART mode can be selected as RS485 or RS232
CAN	CAN	CN16	CAN BUS
LCD	LCD IF	CN24	RGB565 signal interface
	LCD IF	CN8	LVDS 8bit singal interface
	LCD(LVDS) Power Selection	J4	3.3V or 5V, Please pay attention, Wrong selection will damage the LCD screen.
	Res Touch IF	CN7	Resistive touch signal interface(4-Wire or 5-Wire)
	Res/Cap Touch Or I2C	CN29	I2C signal that can be connected to capacitive touch controllder
	BackLight	CN24	PWM output and gpio enable Backlight
	BackLight Power Selection	J4	5V or 12V, Please pay attention, Wrong selection will damage the backlight
RESET	Cold Reset	SW1	PMIC_RESET, cold reset
WATCHDOG	Watchdog Disabled	J3	J3 Closed , External Watchdog Disabled
AUDIO	HeadPhone	CN18	HeadPhone output
	Mic	CN19	Mic Input
MicroSD Card	Micro SD Slot	CN20	Interface for Micro SD Card
Expand IF	Expand IF	CN21	GPMC bus(ADDR and DATA BUS,3.3V)or GPIO

3.1 Power supply

The power supply for EAC-335x is 12 VDC, which is connected to the 2-way connector CN2. The pin assignments of CN2 are shown in the following figures:

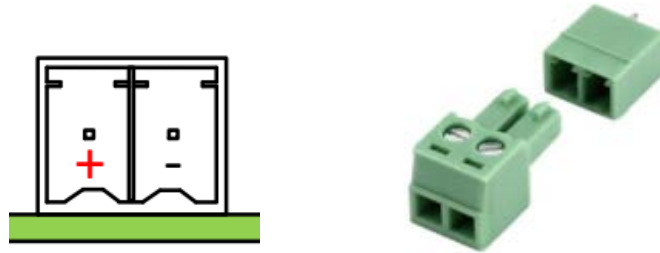

Other power supplies in the design are generated by the on-board regulators, these voltages power the core module and peripherals on the base board. The power rail is as follow:

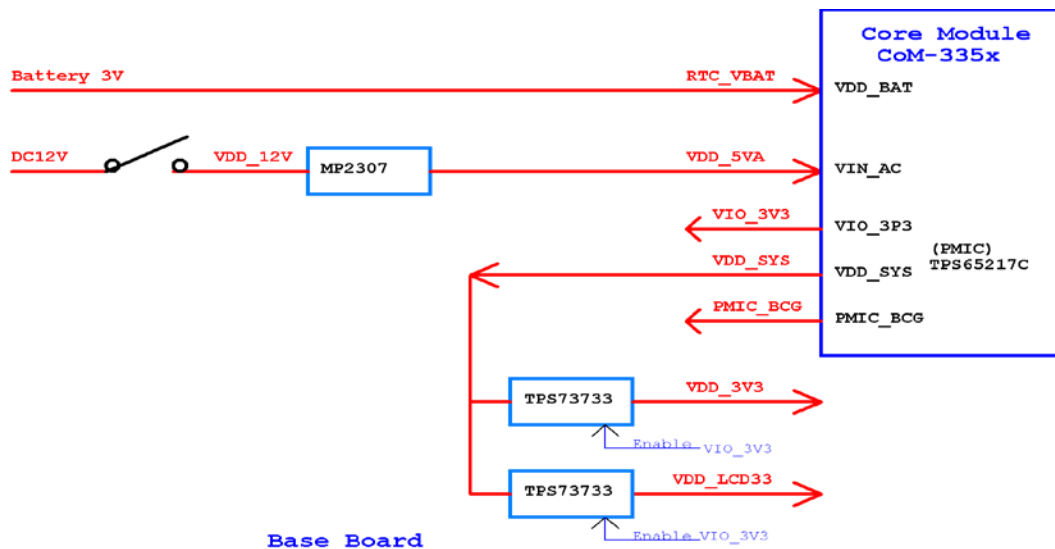

3.2 Battery

A battery for backing up the time and date information can be connected to connector BAT1. The battery is a 3V CR2032 button coin cell battery, and the installation diagram is as follows:

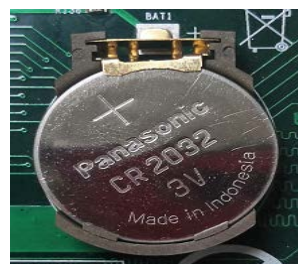

3.3 LEDs

CoM-335x core module is equipped with three LEDs.

The yellow-green "PWR" LED is connected to the VLDO2 output of TPS65217(PMIC), On system startup, this LED is on.

The red "RST" LED is connected to the WARMRSTn of AM335X, and if the LED goes off, the CoM-335x is no longer in reset state.

The yellow-green "RUN" LED is connected to the GPIO3_8 and can be used by the customer in any way whatever. For example, it could indicate that the operating system or a customer application was started successfully.

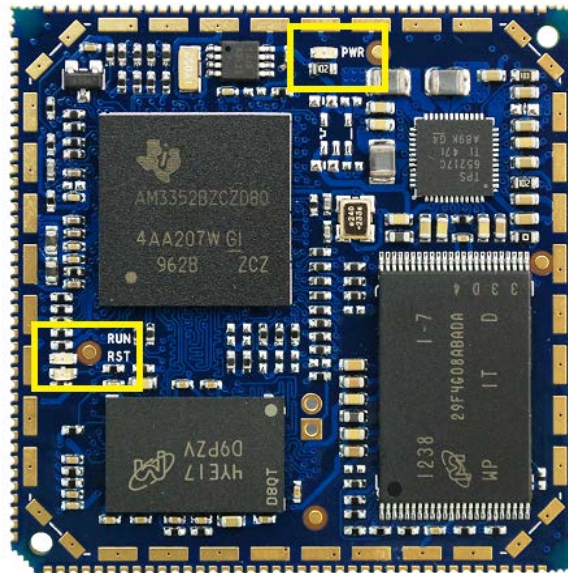

EAC-335x is equipped with four LEDs. Three is for the power LED and one is for user LED.

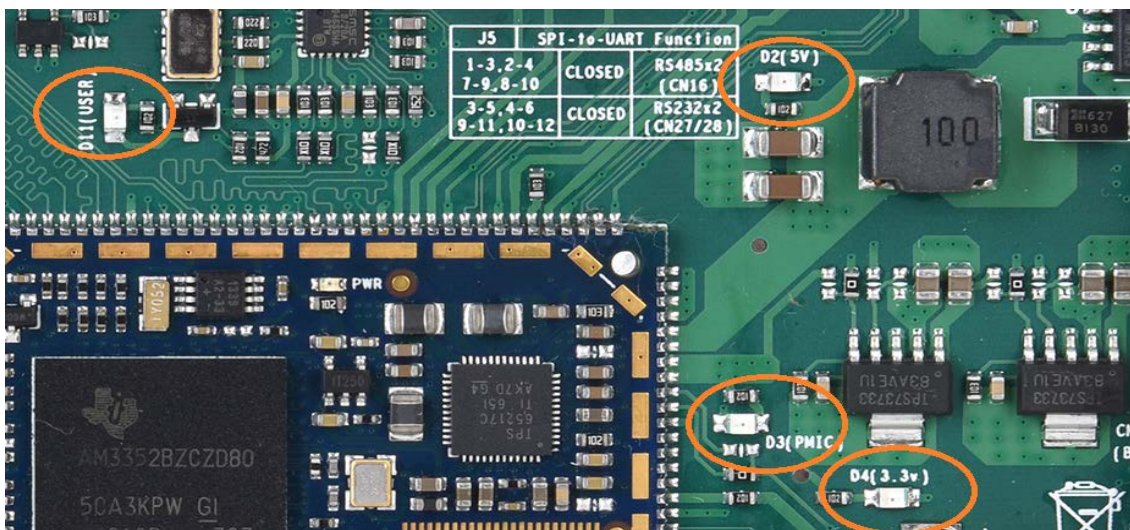

The power LEDs indicate the power supply VDD_5VA (5V) and VDD_3V3 (3.3V) from base board EAC-335x, and VDD_SYS (PMIC) from PMIC on core module. On system startup, all power LEDs are on.

The user LED(D11) is connected to the GPIO3_16 of core module and can be used by the user in any way whatever. For example, it could indicate that the operating system or a customer application was started successfully.

3.4 Boot Sequence SWITCH

EAC-335x single board computer can be started from the following three storage media: NAND, EMMC, micro SD card. In order to meet the needs of various users, we need to change the startup sequence. We design a small switch(SW2) to solve this. For details, please refer to (2.4 CoM-335x boot Sequence).

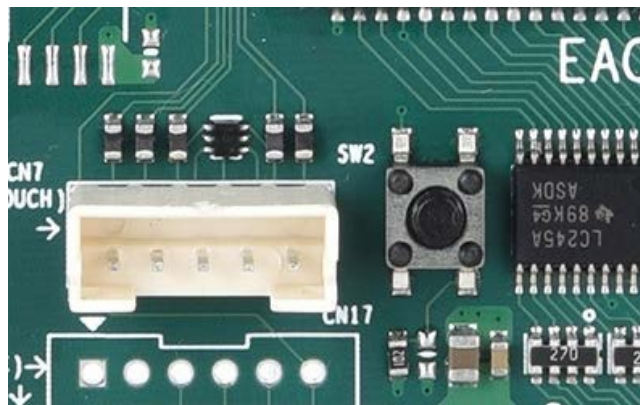

Boot Sequence of EAC-335X (NAND Flash on board)

SW2	1st	2nd	3rd	4th	Description
OFF	NAND	NANDI2C	MMC0	UART0	NAND Flash (NAND) is the default system boot device
Pressed	MMC0	SPI0	UART0	USB0	Through SW2, it can change the boot device to SDcard (MMC0) or the other

Boot Sequence of EAC-335X (eMMC on board)

SW2	1st	2nd	3rd	4th	Description
OFF	MMC1	MMC0	UART0	USB0	eMMC (MMC1) is the default system boot device
Pressed	SPI0	MMC0	USB0	UART0	Through SW2, it can change the boot device to SDcard (MMC0) or the other

3.5 RESET

The reset switch (SW1) is connected to the reset pin of PMIC on core module, so it can reset the PMIC directly and then reset the whole system.

3.6 Ethernet

EAC-335x provides an Ethernet interface designed by connector RJ45 (CN4), supports 10Mbps (10BASE-T) and 100Mbps (100BASE-TX) operation. The connector is equipped with link and speed LEDs.

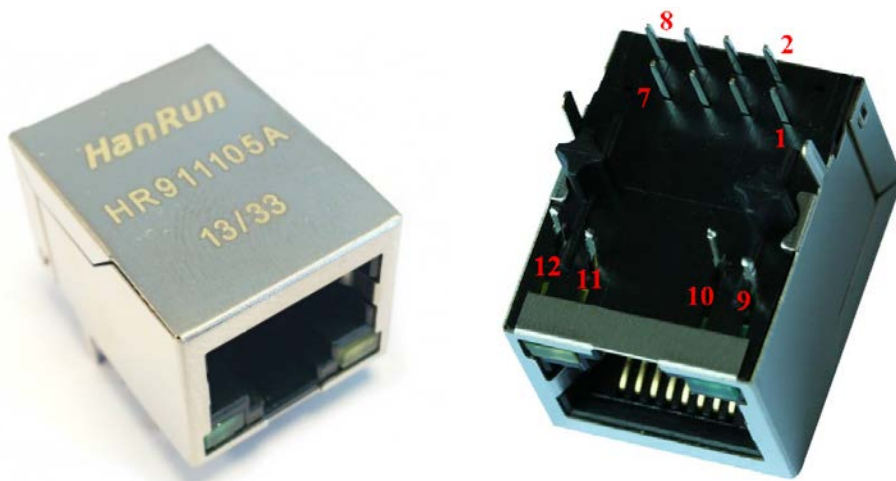

3.7 USB

The core module provides 2 USB OTG ports, USB0 and USB1. The ports support USB 2.0 High-Speed (480Mbps), Full-Speed (12Mbps) and Low-Speed (1.5Mbps) operation in host mode, and support High-Speed, Full-Speed operation in peripheral mode.

EAC-335x uses USB0 for USB OTG (CN10), and USB1 for USB Host (CN9).

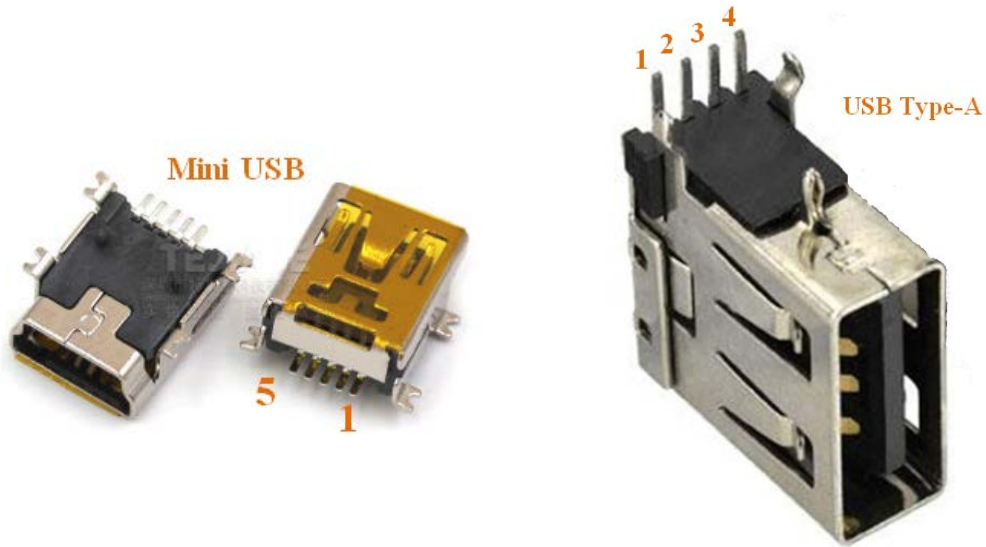

3.8 LCD Display-TTL

EAC-335x provides two TTL signals LCD display ports on PCB. One is 40 position FPC connector (CN5) and the other is 40 position DF13 connector (CN24). One of the two display ports is equipped on the board.

By default, EAC-335x is equipped with CN24 for TTL port. It is optionally with CN17 when ordering.

The pin assignments of FPC connector are as follows:



Table 3-3 LCD FPC connector (CN5) pin assignments

Pin	Name	Description
1	VDD_5VA	Display power 5V
2	VDD_5VA	Display power 5V
3	NC	Not connected
4	NC	Not connected
5	NC	Not connected
6	LCD_B0	LCD display data blue 0
7	LCD_B1	LCD display data blue 1

8	LCD_B2	LCD display data blue 2
9	LCD_B3	LCD display data blue 3
10	LCD_B4	LCD display data blue 4
11	GND	Ground
12	NC	Not connected
13	NC	Not connected
14	LCD_G0	LCD display data green 0
15	LCD_G1	LCD display data green 1
16	LCD_G2	LCD display data green 2
17	LCD_G3	LCD display data green 3
18	LCD_G4	LCD display data green 4
19	LCD_G5	LCD display data green 5
20	GND	Ground
21	NC	Not connected
22	NC	Not connected
23	NC	Not connected
24	LCD_R0	LCD display data red 0
25	LCD_R1	LCD display data red 1
26	LCD_R2	LCD display data red 2
27	LCD_R3	LCD display data red 3
28	LCD_R4	LCD display data red 4
29	GND	Ground
30	LCD_VSC	LCD vertical synchronization
31	LCD_HSC	LCD horizontal synchronization
32	LCD_DOTCK	LCD pixel clock
33	LCD_DEN	LCD data enable
34	NC	Not connected
35	LCD_BLEN	LCD backlight enable
36	GND	Ground
37	I2C_SCL	I2C serial clock
38	I2C_SDA	I2C serial data
39	I2C_INT	I2C Interrupt
40	I2C_NRST	I2C Reset

The pin assignments of DF13 connector are as follows:

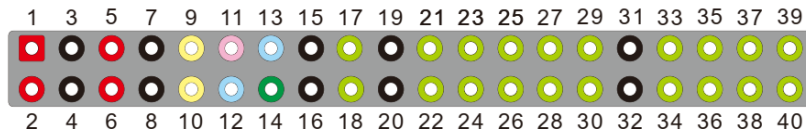
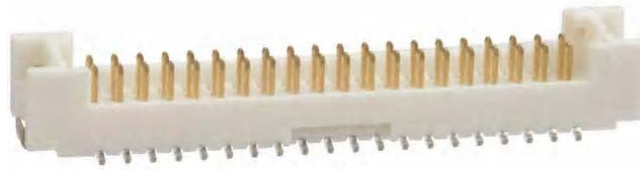

Table 3-4 LCD DF13 (CN24) connector pin assignments

Pin	Name	Description
1	VDD_5VA	Display power 5V(If your LCD needs 5V power supply, please connect this power supply)
2	VDD_5VA	Display power 5V(If your LCD needs 5V power supply, please connect this power supply)
3	GND	Ground
4	GND	Ground
5	VDD_LCD33	Display power 3.3V(If your LCD needs 3.3V power supply, please connect this power supply)
6	VDD_LCD33	Display power 3.3V(If your LCD needs 3.3V power supply, please connect this power supply)
7	NC	Not connected
8	GND	Ground
9	LCD_B0	LCD display data blue 0
10	LCD_B1	LCD display data blue 1
11	LCD_B2	LCD display data blue 2
12	LCD_B3	LCD display data blue 3
13	LCD_B4	LCD display data blue 4
14	NC	Not connected
15	NC	Not connected
16	NC	Not connected
17	LCD_G0	LCD display data green 0
18	LCD_G1	LCD display data green 1
19	LCD_G2	LCD display data green 2
20	LCD_G3	LCD display data green 3
21	LCD_G4	LCD display data green 4
22	LCD_G5	LCD display data green 5
23	NC	Not connected
24	NC	Not connected
25	LCD_R0	LCD display data red 0
26	LCD_R1	LCD display data red 1

27	LCD_R2	LCD display data red 2
28	LCD_R3	LCD display data red 3
29	LCD_R4	LCD display data red 4
30	NC	Not connected
31	NC	Not connected
32	NC	Not connected
33	GND	Ground
34	GND	Ground
35	LCD_DOTCK	LCD pixel clock
36	LCD_VSC	LCD vertical synchronization
37	LCD_DEN	LCD data enable
38	LCD_HSC	LCD horizontal synchronization
39	LCD_BLEN	LCD backlight enable
40	NC	Not connected

3.9 LCD Touch

EAC-335x provides a resistive touch interface (CN7) for the resistive touch screen. And a capacitive touch screen can be realized via the I2C interface (see in chapter 2.19).

The pin assignments of resistive touch connector:

Table 3-5 Resistive touch connector (CN7) pin assignments

Pin	Name	Description
1	RTSC_XM	Touch screen X-
2	RTSC_XP	Touch screen X+
3	RTSC_YM	Touch screen Y-
4	RTSC_YP	Touch screen Y+
5	RTSC_S	For 5-wire resistive touch screen

3.10 LCD Display-LVDS

The EAC-335x is equipped with a LVDS connector (CN8), it is a RM 2.00 connector.

To provide the display with power, EAC-335x is outfitted with two power supplies that can be selected through jumper J4, one is 5V, another one is 3.3V. Users need to choose the right level of power supply according to the panel.

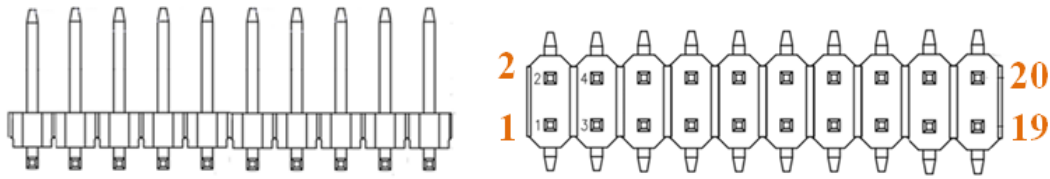

Table 3-6 LVDS connector pin assignments



Pin	Name	Description
1	GND	Ground
2	GND	Ground
3	LVDS_TX0+	LVDS positive display data line 0
4	NC	Not connected
5	LVDS_TX0-	LVDS negative display data line 0
6	NC	Not connected
7	LVDS_TX1+	LVDS positive display data line 1
8	NC	Not connected
9	LVDS_TX1-	LVDS negative display data line 1
10	NC	Not connected
11	LVDS_TX2+	LVDS positive display data line 2
12	NC	Not connected
13	LVDS_TX2-	LVDS negative display data line 2
14	NC	Not connected
15	LVDS_CLK+	LVDS positive clock line
16	LVDS_TX3+	LVDS positive display data line 3
17	LVDS_CLK-	LVDS negative clock line
18	LVDS_TX3-	LVDS negative display data line 3
19	LVDS_PWR	LVDS power, can be 5V or 3.3V, select through jumper J4
20	LVDS_PWR	LVDS power, can be 5V or 3.3V, select through jumper J4

Table 3-7 LVDS power selection jumper (J4) pin assignments

Pin	Name	Description
1	VDD_5VA	Power 5V
2	LVDS_PWR	LVDS power
3	VDD_LCD33	Power 3.3V

Table 3-8 LVDS power selection

Jumper	LVDS power	Operation	Diagram
--------	------------	-----------	---------

J4	5V	Shorting pins 1-2 Floating pin 3	
	3.3V	Shorting pins 2-3 Floating pin 1	

3.11 Backlight

The EAC-335x is equipped with a backlight connector (CN6), it is a RM 2.00 connector.

For the backlight power, EAC-335x provides two power supplies, 12V and 5V, selected through jumper J6. Users need to choose the right level of power supply according to the panel.



The pin assignments of backlight connector and power selection are as follows:

Table 3-9 Backlight connector (CN6) pin assignments

Pin	Name	Description
1	VCC	Backlight Power, can be 12V or 5V, select through jumper J6
2	VCC	
3	GND	Ground
4	GND	Ground
5	ON/OFF	Backlight on/off(GPIO1_28,3.3V)
6	PWM	Backlight dimming(GPIO3_17,3.3V)

Table 3-10 Backlight power selection jumper (J6) pin assignments

Pin	Name	Description
1	VDD_12V	Power 12V
2	VDD_12V	Power 12V
3	LCD_BLPWR	Backlight Power
4	LCD_BLPWR	Backlight Power
5	VDD_5VA	Power 5V
6	VDD_5VA	Power 5V

Table 3-11 LCD backlight power selection

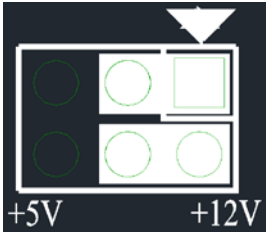
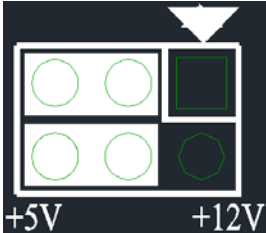
Jumper	Backlight power	Operation	Diagram
J6	12V	Shorting pins 1-3,2-4 Floating pins 5,6	
	5V	Shorting pins 3-5,4-6 Floating pins 1,2	

3.12 RS232/TTL

EAC-335x can be equipped with up to 7 RS232 ports. All the ports are connected to the RM 2.54 connectors. For every RS232 port, there is an RS232 transceiver integrated onboard between the core module and the connector.

COM2 to COM4 can be used as the TTL ports when the resistances replace the RS232 transceivers. The levels of these serial ports are optional when ordering.

The information of COM ports is shown in the table below:

Table 3-12 UART description

COM ports	Description
COM0 (CN11)	Debug COM port, RS232 level
COM1 (CN12)	RS232 port

COM2 (CN13)	RS232 ports, can be optionally ordered with the TTL level on these ports
COM3 (CN14)	
COM4 (CN15)	
COM5 (CN27)	RS232 ports, multiplexing the extension UART signals with RS485 ports . It needs to be selected through jumper J5
COM6 (CN28)	

Note: COM0 is the debug COM port. The bootloader of the core module can be accessed via the COM0 and the Linux console in the standard image can also be operated via this port.

Note: RS232 ports (CN27/CN28) and RS485 port (CN16) are not available simultaneously. Users need to select the correct mode through jumper J5. See in Chapter 2.13 for detail.

The 5-way RS232/TTL connectors are assigned as follows:



Table 3-13 RS232/TTL ports pin assignments

Pin	Name	Description
1	VCC	VDD_5VA
2	GND	Ground
3	TXD	Transmit data line
4	RXD	Receive data line

3.13 RS485+CAN

The connector CN16 on EAC-335x provides two RS485 ports and one CAN interface.

The CAN interface is connected to CAN0 of core module through a CAN bus transceiver. It supports programmable data rates up to 1 Mbps.

The RS485 ports are connected to extension UART ports from the transceiver XR20M1172. Two RS485 transceivers are integrated onboard between the extension UART ports and the connector.

At the same time, the extension UART ports are reused to the RS232 ports CN27 and CN28. Before using the extension UART ports, users must select the correct mode through

jumper J5. The RS232 ports (CN27/CN28) and RS485 port (CN16) are not available simultaneously.

The pin assignments of RS485+CAN connector and select modes of J5 are as follows:

Table 3-14 RS485+CAN connector pin assignments

Pin	Name	Description
1	COM5_RS485_A	RS485 data A
2	COM5_RS485_B	RS485 data B
3	COM6_RS485_A	RS485 data A
4	COM6_RS485_B	RS485 data B
5	CAN_L	CAN Low
6	CAN_H	CAN High

Note: The pin assignments of RS232 port, see in Chapter 2.12.

Table 3-15 RS485/RS232 mode selection jumper (J5) pin assignments

Pin	Name	Description
1	TXA_485	RS485 data A
2	RXA_485	RS485 data B
3	TXA	Transmit data line of extension UART port A
4	RXA	Receive data line of extension UART port A
5	TXA_232	RS232 transmit data line
6	RXA_232	RS232 receive data line
7	TXB_485	RS485 data A
8	RXB_485	RS485 data B
9	TXB	Transmit Data line of extension UART port B
10	RXB	Receive Data line of extension UART port B
11	TXB_232	RS232 transmit data line
12	RXB_232	RS232 receive data line

Table 3-16 RS485/RS232 mode selection

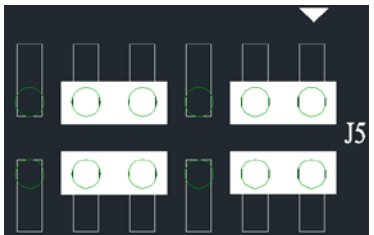
Jumper	UART level	Operation	Diagram
J5	RS485	Shorting pins 1-3,2-4,7-9,8-10 Floating pins 5,6,11,12	

	RS232	Shorting pins 3-5,4-6,9-11,10-12 Floating pins 1,2,7,8	
--	-------	---	--

3.14 Audio

EAC-335x is equipped with an audio module, provides a Headphone Jack (CN18) and a MIC (CN19) interface.



By default, the MIC interface is not equipped. The interface is optional when ordering. The MIC interface is an RM 2.00, 1x3 connector, and the pin assignments are as follows:



Table 3-17 MIC interface pin assignments

Pin	Name	Description
1	MIC_BIAS	Microphone bias voltage output
2	MIC_IN	MIC input
3	AGND_AUD	Audio analog ground

3.15 WatchDog

EAC-335x is equipped with a watchdog, supports soft reset. The timer's time interval is 10s.

If want to disable the watchdog reset, it can short the jumper J3 or set the GPIO0_6 (WDG_SHDN) to high.

3.16 Buzzer

EAC-335x is equipped with an onboard buzzer, which is driven by the GPIO3_4 of core module.

3.17 Micro SDCard

EAC-335x provides a Micro SDCard slot (CN20) designed by mmc0 port of core module, it can support up to 192Mbps data transfer rate in High-Speed mode.



Table 3-18 Micro SDCard slot (CN20) pin assignments

Pin	Name	Description
1	DAT2	Data line 2
2	CD/DAT3	Card detect/Data line 3
3	CMD	Command line
4	VDD	Supply voltage, 3.3V
5	CLK	Clock
6	VSS	Ground
7	DAT0	Data line 0
8	DAT1	Data line 1
9	CD	Card detect

3.18 GPMC Bus

The EAC-335x can be equipped with a GPMC bus (CN21) when the core module is equipped with NAND Flash memory.

Table 2-19 GPMC bus connector pin assignments

Pin	Name	Description	Voltage Level
1	GND	Ground	
2	GPMC_D0	Data 0 (Cannot be configured as GPIO, it can be used as data bus)	3.3V
3	GPMC_D1	Data 1(Same as upper part)	3.3V
4	GPMC_D2	Data 2(Same as upper part)	3.3V
5	GPMC_D3	Data 3(Same as upper part)	3.3V
6	GPMC_D4	Data 4(Same as upper part)	3.3V
7	GPMC_D5	Data 5(Same as upper part)	3.3V
8	GPMC_D6	Data 6(Same as upper part)	3.3V
9	GPMC_D7	Data 7(Same as upper part)	3.3V
10	GND	Ground	
11	GPMC_D8	Data 8 (Can be configured as GPIO or data bus)	3.3V
12	GPMC_D9	Data 9(Same as upper part)	3.3V
13	GPMC_D10	Data 10(Same as upper part)	3.3V
14	GPMC_D11	Data 11(Same as upper part)	3.3V
15	GPMC_D12	Data 12(Same as upper part)	3.3V
16	GPMC_D13	Data 13(Same as upper part)	3.3V
17	GPMC_D14	Data 14(Same as upper part)	3.3V
18	GPMC_D15	Data 15(Same as upper part)	3.3V
19	GND	Ground	
20	GPMC_A0	Address output 0 (Can be configured as GPIO or addr bus)	3.3V
21	GPMC_A1	Address output 1(Same as upper part)	3.3V
22	GPMC_A2	Address output 2(Same as upper part)	3.3V
23	GPMC_A3	Address output 3(Same as upper part)	3.3V
24	GPMC_A4	Address output 4(Same as upper part)	3.3V
25	GPMC_A5	Address output 5(Same as upper part)	3.3V
26	GPMC_A6	Address output 6(Same as upper part)	3.3V
27	GPMC_A7	Address output 7(Same as upper part)	3.3V
28	GPMC_A8	Address output 8(Same as upper part)	3.3V
29	GPMC_A9	Address output 9(Same as upper part)	3.3V
30	GPMC_A10	Address output 10(Same as upper part)	3.3V
31	GPMC_A11	Address output 11(Same as upper part)	3.3V
32	GND	Ground	
33	SYS_Nrst	System reset	
34	GPMC_CSn2	Chip select 2 (active low ,Can be configured as GPIO)	3.3V
35	GPMC_CSn3	Chip select 3 (active low,Can be configured as GPIO)	3.3V
36	GPMC_BEn0	Lower Byte Enable (active low, Cannot be configured as GPIO)	3.3V
37	NC	Not connected	

38	GPMC_WEn	Write Enable (active low, Cannot be configured as GPIO)	3.3V
39	GPMC_REn	Read Enable (active low, Cannot be configured as GPIO)	3.3V
40	GPMC_ALE	Address Latch Enable (Cannot be configured as GPIO)	3.3V
41	GPMC_WAIT0	External wait signal(Cannot be configured as GPIO)	3.3V
42	GPMC_INT	Interrupt	3.3V
43	VDD_5VA	Power supply 5V	
44	VDD_5VA	Power supply 5V	

3.19 I2C Bus

EAC-335x is equipped with an I2C interface that is connected to the I2C2 ports of core module. The I2C interface can be used for the application of capacitive touch screen.

EAC-335x provides two type connectors for the I2C interface on PCB. Two connectors are pin-to-pin connected, and one of them is equipped on the board.

By default, EAC-335x is equipped with the RM 2.54 connector (CN29). It is optionally with an RM 2.00 connector (CN17) when ordering.

The pin assignments are as follows:

Table 2-19 I2C interface (CN17/CN29) pin assignments

Pin	Name	Description
1	VDD_3V3	Power 3.3V
2	GND	Ground
3	I2C_SCL	I2C serial clock
4	I2C_SDA	I2C serial data
5	I2C_INT	I2C Interrupt
	I2C_NRST	I2C Reset

4 Electronic Characteristics

4.1 Power Supply Electrical Characteristics

Table 4-1 Power Supply Electrical Characteristics

Parameter	Description	Min	Typ.	Max	Unit
VDD_12V	Main power supply.	9	12	14	V
I _{VDD_12V}	Supply Current	--	--	3	A
RTC_VBAT	Backup power supply for RTC.	1.3	3.0	3.7	V
I _{RTC_VBAT}	RTC Current	--	10	100	nA

4.2 IO Electrical Characteristics

Table 4-2 IO Electrical Characteristics

Parameter	Description	Min	Typ.	Max	Unit
V _{IH}	High-level input voltage.	2		3.3	V
V _{IL}	Low-level input voltage.	0		0.8	V
V _{OH}	High-level output voltage.	2.85		--	V
V _{OL}	Low-level output voltage.	0		0.45	V

4.3 Operating Temperature Ranges

Table 4-3 Temperature Range Options

Rang	Temperature
Commercial	0 to 70 °C
Extended	-20 to 70 °C
Industrial	-30 to 80 °C

5 Mechanical Characteristics

- Size: 120 x 120 x 1.6 mm
- PCB: 4 layers design, Immersion Gold, Lead-Free

Mechanical drawing is shown in Figure 4-1.

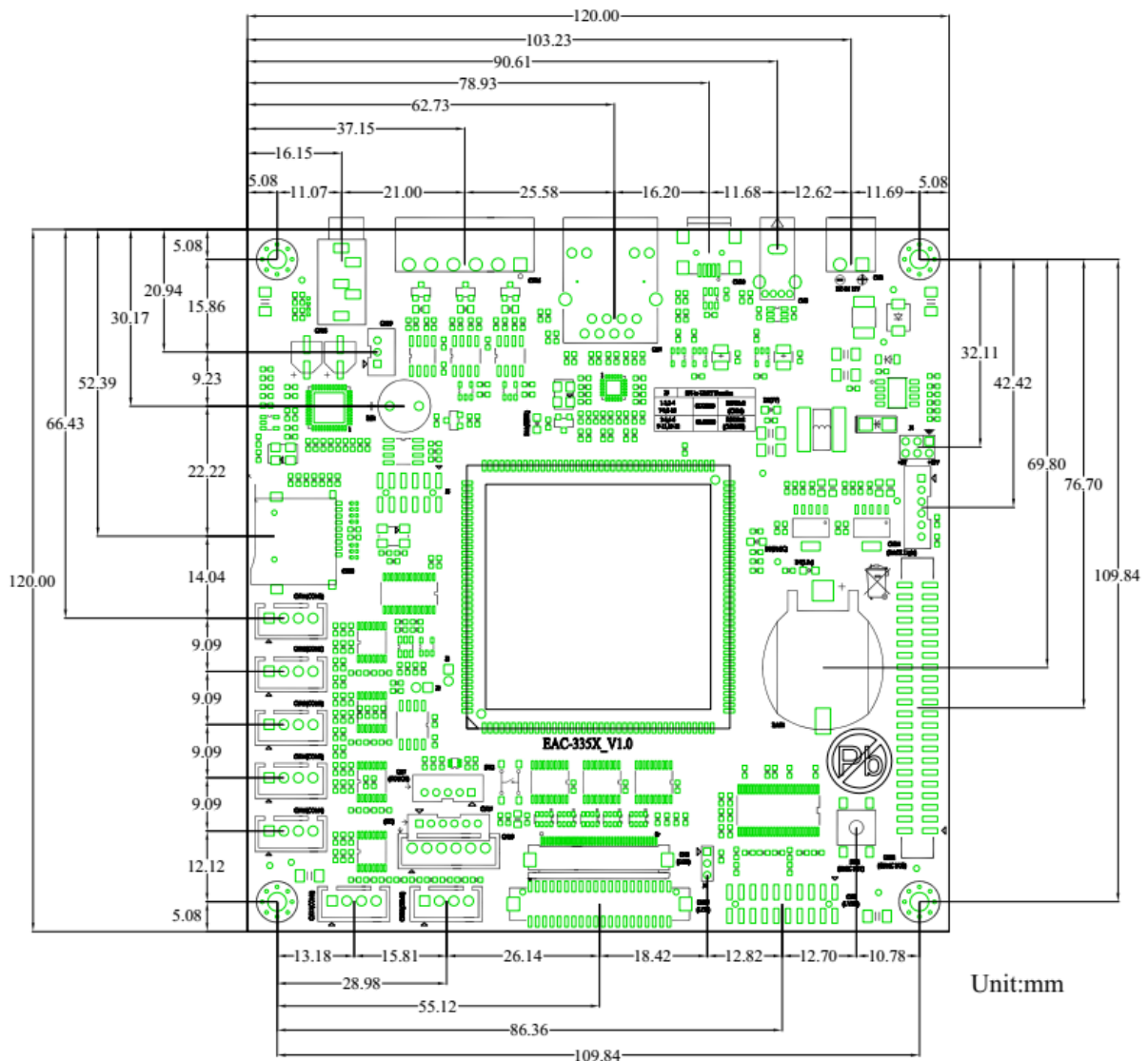

Fig. 5-1 Mechanical Drawing of EAC-335x